

2-Hour Fire Rating

8" C.M.U.

Fire Rating: 2 Hour

No. 8-2-910720

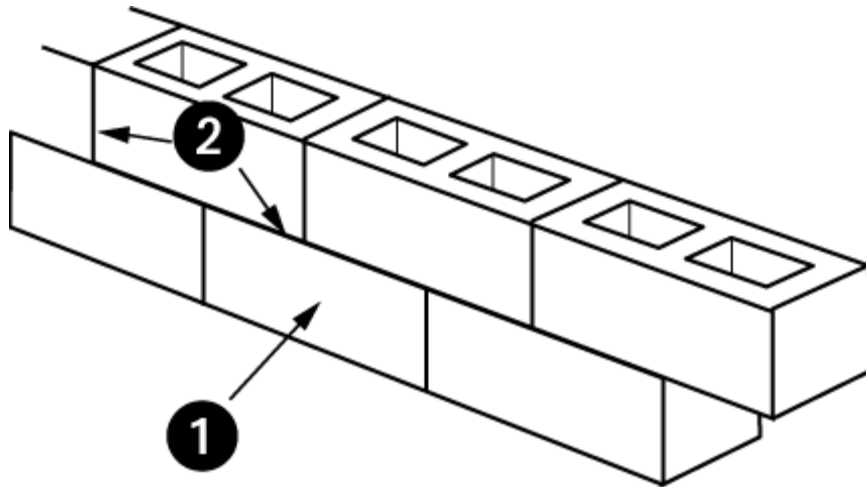

Assembly Information

1. Preferred product 910720 c.m.u. 8" x 8" x 18" nominal
2. ASTM C-270 Masonry Mortar, Type M or S. Face shell or full mortar bedding as required.
3. Masonry grout, reinforcing steel, joint reinforcement, anchors, ties and accessories (Not depicted above - optional). Use where specified.

Preferred Materials Inc. accepts no responsibility for proper application of the rated wall assembly above, or responsibility for the construction of such assemblies.

Fire Rating: 2 Hour No. 8-2-910720

Concrete Masonry Unit

Section 721.3.2 of the Florida Building Code

Unit Description	Size WxHxL Nominal	Equivalent Thickness Inches	Fire Rating Minutes
910720	8x8x18	4.1	120.5*

** Linear interpolation from Table 721.3.2 of the Florida Building Code for Exposed Finish Block Mix – 55% limestone & 45% siliceous aggregates.*

Section 721.3.1.3 and 721.3.1.4 of the Florida Building Code

Solid Grouted construction and/or cells filled with loose-fill materials

Included	Equivalent Thickness Inches	Fire Rating Minutes
No	4.1	120.5
Yes	N/A	N/A

** Linear interpolation from Table 721.3.2 of the Florida Building Code for Exposed Finish Block Mix – 55% limestone & 45% siliceous aggregates.*

Fire Rating: 2 Hour No. 8-2-910720

Nonfire-exposed side

Side 1

Section 721.3.2.1 of the Florida Building Code

Finish	
None	0
Multiplying factor Table 721.2.1.4(1)	N/A
Adjusted Thickness	0
Concrete Masonry Unit	
Unit Description	910720
Size WxHxL Nominal	8x8x18
Equivalent Thickness	4.1
Fire Rating Minutes	120.5
Total Thickness, CMU + Finish	4.1
Fire Resistance Rating of CMU & Finish, Table 721.3.2	120.5*

** Linear interpolation from Table 721.3.2 of the Florida Building Code for Exposed Finish Block Mix – 55% limestone & 45% siliceous aggregates.*

Side 2

Section 721.3.2.1 of the Florida Building Code

Finish	
None	0
Multiplying factor Table 721.2.1.4(1)	N/A
Adjusted Thickness (inches)	0
Concrete Masonry Unit	
Unit Description	910720
Size WxHxL Nominal	8x8x18
Equivalent Thickness (inches)	4.1
Fire Rating Minutes	120.5
Total Thickness, CMU + Finish (inches)	4.1
Fire Resistance Rating of CMU & Finish, Table 721.3.2	120.5*

** Linear interpolation from Table 721.3.2 of the Florida Building Code for Exposed Finish Block Mix – 55% limestone & 45% siliceous aggregates.*

Fire Rating: 2 Hour No. 8-2-910720

Fire-exposed side

Side 1

Section 721.3.2.2 of the Florida Building Code

Finish	
None	
Time assigned to finish materials Table 721.2.1.4(2)	0
Fire Resistance of CMU and Nonfire-exposed side Finish Table 721.3.2	120.5
Assembly Fire-Resistance Rating	120.5
Max. allowable assembly Fire Resistance Block + finishes	241
Total Assembly Fire-Resistance Rating	120.5

Side 2

Section 721.3.2.2 of the Florida Building Code

Finish	
None	
Time assigned to finish materials Table 721.2.1.4(2)	0
Fire Resistance of CMU and Nonfire-exposed side Finish Table 721.3.2	120.5
Assembly Fire-Resistance Rating	120.5
Max. allowable assembly Fire Resistance Block + finishes	241
Total Assembly Fire-Resistance Rating	120.5

Assembly Fire-Resistance Rating	120.5 Minutes
--	----------------------

Fire Resistance Rating, minutes per inches of equivalent thickness
Linear Interpolation from table 721.3.2 of the 2007 Florida Building Code
Exposed Finish Block Mix – 55% Limestone & 45% Siliceous Aggregates

1.95	30.0	2.36	45.4	2.77	60.8	3.18	76.3	3.59	95.0	4.00	115.5	4.41	136.2	4.82	160.8	5.23	186.8	5.64	210.0
1.96	30.4	2.37	45.8	2.78	61.1	3.19	76.8	3.60	95.5	4.01	116.0	4.42	136.8	4.83	161.4	5.24	187.5	5.65	210.8
1.97	30.8	2.38	46.1	2.79	61.5	3.20	77.2	3.61	96.0	4.02	116.5	4.43	137.4	4.84	162.0	5.25	188.3	5.66	211.5
1.98	31.1	2.39	46.5	2.80	61.9	3.21	77.6	3.62	96.5	4.03	117.0	4.44	138.0	4.85	162.6	5.26	189.0	5.67	212.3
1.99	31.5	2.40	46.9	2.81	62.3	3.22	78.1	3.63	97.0	4.04	117.5	4.45	138.6	4.86	163.2	5.27	189.8	5.68	213.0
2.00	31.9	2.41	47.3	2.82	62.6	3.23	78.5	3.64	97.5	4.05	118.0	4.46	139.2	4.87	163.8	5.28	190.5	5.69	213.8
2.01	32.3	2.42	47.6	2.83	63.0	3.24	79.0	3.65	98.0	4.06	118.5	4.47	139.8	4.88	164.4	5.29	191.3	5.70	214.5
2.02	32.6	2.43	48.0	2.84	63.4	3.25	79.4	3.66	98.5	4.07	119.0	4.48	140.4	4.89	165.0	5.30	192.0	5.71	215.3
2.03	33.0	2.44	48.4	2.85	63.7	3.26	79.9	3.67	99.0	4.08	119.5	4.49	141.0	4.90	165.6	5.31	192.8	5.72	216.0
2.04	33.4	2.45	48.7	2.86	64.1	3.27	80.3	3.68	99.5	4.09	120.0	4.50	141.6	4.91	166.2	5.32	193.5	5.73	216.8
2.05	33.8	2.46	49.1	2.87	64.5	3.28	80.7	3.69	100.0	4.10	120.5	4.51	142.2	4.92	166.8	5.33	194.3	5.74	217.5
2.06	34.1	2.47	49.5	2.88	64.9	3.29	81.2	3.70	100.5	4.11	121.0	4.52	142.8	4.93	167.4	5.34	195.0	5.75	218.3
2.07	34.5	2.48	49.9	2.89	65.2	3.30	81.6	3.71	101.0	4.12	121.5	4.53	143.4	4.94	168.0	5.35	195.5	5.76	219.0
2.08	34.9	2.49	50.2	2.90	65.6	3.31	82.1	3.72	101.5	4.13	122.0	4.54	144.0	4.95	168.6	5.36	196.0	5.77	219.8
2.09	35.2	2.50	50.6	2.91	66.0	3.32	82.5	3.73	102.0	4.14	122.5	4.55	144.6	4.96	169.2	5.37	196.5	5.78	220.5
2.10	35.6	2.51	51.0	2.92	66.4	3.33	82.9	3.74	102.5	4.15	123.0	4.56	145.2	4.97	169.8	5.38	197.0	5.79	221.3
2.11	36.0	2.52	51.4	2.93	66.7	3.34	83.4	3.75	103.0	4.16	123.5	4.57	145.8	4.98	170.4	5.39	197.5	5.80	222.0
2.12	36.4	2.53	51.7	2.94	67.1	3.35	83.8	3.76	103.5	4.17	124.0	4.58	146.4	4.99	171.0	5.40	198.0	5.81	222.8
2.13	36.7	2.54	52.1	2.95	67.5	3.36	84.3	3.77	104.0	4.18	124.5	4.59	147.0	5.00	171.6	5.41	198.5	5.82	223.5
2.14	37.1	2.55	52.5	2.96	67.9	3.37	84.7	3.78	104.5	4.19	125.0	4.60	147.6	5.01	172.2	5.42	199.0	5.83	224.3
2.15	37.5	2.56	52.9	2.97	68.2	3.38	85.1	3.79	105.0	4.20	125.5	4.61	148.2	5.02	172.8	5.43	199.5	5.84	225.0
2.16	37.9	2.57	53.2	2.98	68.6	3.39	85.6	3.80	105.5	4.21	126.0	4.62	148.8	5.03	173.4	5.44	200.0	5.85	225.8
2.17	38.2	2.58	53.6	2.99	69.0	3.40	86.0	3.81	106.0	4.22	126.5	4.63	149.4	5.04	174.0	5.45	200.5	5.86	226.5
2.18	38.6	2.59	54.0	3.00	69.4	3.41	86.5	3.82	106.5	4.23	127.0	4.64	150.0	5.05	174.6	5.46	201.0	5.87	227.3
2.19	39.0	2.60	54.4	3.01	69.7	3.42	86.9	3.83	107.0	4.24	127.5	4.65	150.6	5.06	175.2	5.47	201.5	5.88	228.0
2.20	39.4	2.61	54.7	3.02	70.1	3.43	87.3	3.84	107.5	4.25	128.0	4.66	151.2	5.07	175.8	5.48	202.0	5.89	228.8
2.21	39.7	2.62	55.1	3.03	70.5	3.44	87.8	3.85	108.0	4.26	128.5	4.67	151.8	5.08	176.4	5.49	202.5	5.90	229.5
2.22	40.1	2.63	55.5	3.04	70.9	3.45	88.2	3.86	108.5	4.27	129.0	4.68	152.4	5.09	177.0	5.50	203.0	5.91	230.3
2.23	40.5	2.64	55.9	3.05	71.2	3.46	88.7	3.87	109.0	4.28	129.5	4.69	153.0	5.10	177.6	5.51	203.5	5.92	231.0
2.24	40.9	2.65	56.2	3.06	71.6	3.47	89.1	3.88	109.5	4.29	130.0	4.70	153.6	5.11	178.2	5.52	204.0	5.93	231.8
2.25	41.2	2.66	56.6	3.07	72.0	3.48	89.6	3.89	110.0	4.30	130.5	4.71	154.2	5.12	178.8	5.53	204.5	5.94	232.5
2.26	41.6	2.67	57.0	3.08	72.4	3.49	90.0	3.90	110.5	4.31	131.0	4.72	154.8	5.13	179.4	5.54	205.0	5.95	233.3
2.27	42.0	2.68	57.4	3.09	72.7	3.50	90.5	3.91	111.0	4.32	131.5	4.73	155.4	5.14	180.0	5.55	205.5	5.96	234.0
2.28	42.4	2.69	57.7	3.10	73.1	3.51	91.0	3.92	111.5	4.33	132.0	4.74	156.0	5.15	180.8	5.56	206.0	5.97	234.8
2.29	42.7	2.70	58.1	3.11	73.5	3.52	91.5	3.93	112.0	4.34	132.5	4.75	156.6	5.16	181.5	5.57	206.5	5.98	235.5
2.30	43.1	2.71	58.5	3.12	73.9	3.53	92.0	3.94	112.5	4.35	133.0	4.76	157.2	5.17	182.3	5.58	207.0	5.99	236.3
2.31	43.5	2.72	58.9	3.13	74.2	3.54	92.5	3.95	113.0	4.36	133.5	4.77	157.8	5.18	183.0	5.59	207.5	6.00	237.0
2.32	43.9	2.73	59.2	3.14	74.6	3.55	93.0	3.96	113.5	4.37	134.0	4.78	158.4	5.19	183.8	5.60	208.0	6.01	237.8
2.33	44.2	2.74	59.6	3.15	75.0	3.56	93.5	3.97	114.0	4.38	134.5	4.79	159.0	5.20	184.5	5.61	208.5	6.02	238.5
2.34	44.6	2.75	60.0	3.16	75.4	3.57	94.0	3.98	114.5	4.39	135.0	4.80	159.6	5.21	185.3	5.62	209.0	6.03	239.3
2.35	45.0	2.76	60.4	3.17	75.9	3.58	94.5	3.99	115.0	4.40	135.6	4.81	160.2	5.22	186.0	5.63	209.5	6.04	240.0

Fire Resistance Rating, minutes per inches of equivalent thickness
Direct Interpolation from table 721.3.2 of the 2007 Florida Building Code
Stucco/Sand Finish Block Mix – 100% Limestone

1.90	30.0	2.31	45.4	2.72	60.8	3.13	76.5	3.54	97.0	3.95	117.5	4.36	139.5	4.77	163.5	5.18	193.5	5.59	216.8
1.91	30.4	2.32	45.8	2.73	61.1	3.14	77.0	3.55	97.5	3.96	118.0	4.37	140.3	4.78	164.0	5.19	194.3	5.60	217.5
1.92	30.8	2.33	46.1	2.74	61.5	3.15	77.5	3.56	98.0	3.97	118.5	4.38	141.0	4.79	164.5	5.20	195.0	5.61	218.3
1.93	31.1	2.34	46.5	2.75	61.9	3.16	78.0	3.57	98.5	3.98	119.0	4.39	141.8	4.80	165.0	5.21	195.5	5.62	219.0
1.94	31.5	2.35	46.9	2.76	62.3	3.17	78.5	3.58	99.0	3.99	119.5	4.40	142.5	4.81	165.8	5.22	196.0	5.63	219.8
1.95	31.9	2.36	47.3	2.77	62.6	3.18	79.0	3.59	99.5	4.00	120.0	4.41	143.3	4.82	166.5	5.23	196.5	5.64	220.5
1.96	32.3	2.37	47.6	2.78	63.0	3.19	79.5	3.60	100.0	4.01	120.5	4.42	144.0	4.83	167.3	5.24	197.0	5.65	221.3
1.97	32.6	2.38	48.0	2.79	63.4	3.20	80.0	3.61	100.5	4.02	121.0	4.43	144.8	4.84	168.0	5.25	197.5	5.66	222.0
1.98	33.0	2.39	48.4	2.80	63.7	3.21	80.5	3.62	101.0	4.03	121.5	4.44	145.5	4.85	168.8	5.26	198.0	5.67	222.8
1.99	33.4	2.40	48.8	2.81	64.1	3.22	81.0	3.63	101.5	4.04	122.0	4.45	146.3	4.86	169.5	5.27	198.5	5.68	223.5
2.00	33.8	2.41	49.1	2.82	64.5	3.23	81.5	3.64	102.0	4.05	122.5	4.46	147.0	4.87	170.3	5.28	199.0	5.69	224.3
2.01	34.1	2.42	49.5	2.83	64.9	3.24	82.0	3.65	102.5	4.06	123.0	4.47	147.8	4.88	171.0	5.29	199.5	5.70	225.0
2.02	34.5	2.43	49.9	2.84	65.2	3.25	82.5	3.66	103.0	4.07	123.5	4.48	148.5	4.89	171.8	5.30	200.0	5.71	225.8
2.03	34.9	2.44	50.3	2.85	65.6	3.26	83.0	3.67	103.5	4.08	124.0	4.49	149.3	4.90	172.5	5.31	200.5	5.72	226.5
2.04	35.3	2.45	50.6	2.86	66.0	3.27	83.5	3.68	104.0	4.09	124.5	4.50	150.0	4.91	173.3	5.32	201.0	5.73	227.3
2.05	35.6	2.46	51.0	2.87	66.4	3.28	84.0	3.69	104.5	4.10	125.0	4.51	150.5	4.92	174.0	5.33	201.5	5.74	228.0
2.06	36.0	2.47	51.4	2.88	66.7	3.29	84.5	3.70	105.0	4.11	125.5	4.52	151.0	4.93	174.8	5.34	202.0	5.75	228.8
2.07	36.4	2.48	51.7	2.89	67.1	3.30	85.0	3.71	105.5	4.12	126.0	4.53	151.5	4.94	175.5	5.35	202.5	5.76	229.5
2.08	36.7	2.49	52.1	2.90	67.5	3.31	85.5	3.72	106.0	4.13	126.5	4.54	152.0	4.95	176.3	5.36	203.0	5.77	230.3
2.09	37.1	2.50	52.5	2.91	67.9	3.32	86.0	3.73	106.5	4.14	127.0	4.55	152.5	4.96	177.0	5.37	203.5	5.78	231.0
2.10	37.5	2.51	52.9	2.92	68.2	3.33	86.5	3.74	107.0	4.15	127.5	4.56	153.0	4.97	177.8	5.38	204.0	5.79	231.8
2.11	37.9	2.52	53.2	2.93	68.6	3.34	87.0	3.75	107.5	4.16	128.0	4.57	153.5	4.98	178.5	5.39	204.5	5.80	232.5
2.12	38.2	2.53	53.6	2.94	69.0	3.35	87.5	3.76	108.0	4.17	128.5	4.58	154.0	4.99	179.3	5.40	205.0	5.81	233.3
2.13	38.6	2.54	54.0	2.95	69.4	3.36	88.0	3.77	108.5	4.18	129.0	4.59	154.5	5.00	180.0	5.41	205.5	5.82	234.0
2.14	39.0	2.55	54.4	2.96	69.7	3.37	88.5	3.78	109.0	4.19	129.5	4.60	155.0	5.01	180.8	5.42	206.0	5.83	234.8
2.15	39.4	2.56	54.7	2.97	70.1	3.38	89.0	3.79	109.5	4.20	130.0	4.61	155.5	5.02	181.5	5.43	206.5	5.84	235.5
2.16	39.7	2.57	55.1	2.98	70.5	3.39	89.5	3.80	110.0	4.21	130.5	4.62	156.0	5.03	182.3	5.44	207.0	5.85	236.3
2.17	40.1	2.58	55.5	2.99	70.9	3.40	90.0	3.81	110.5	4.22	131.0	4.63	156.5	5.04	183.0	5.45	207.5	5.86	237.0
2.18	40.5	2.59	55.9	3.00	71.2	3.41	90.5	3.82	111.0	4.23	131.5	4.64	157.0	5.05	183.8	5.46	208.0	5.87	237.8
2.19	40.9	2.60	56.2	3.01	71.6	3.42	91.0	3.83	111.5	4.24	132.0	4.65	157.5	5.06	184.5	5.47	208.5	5.88	238.5
2.20	41.2	2.61	56.6	3.02	72.0	3.43	91.5	3.84	112.0	4.25	132.5	4.66	158.0	5.07	185.3	5.48	209.0	5.89	239.3
2.21	41.6	2.62	57.0	3.03	72.4	3.44	92.0	3.85	112.5	4.26	133.0	4.67	158.5	5.08	186.0	5.49	209.5	5.90	240.0
2.22	42.0	2.63	57.4	3.04	72.7	3.45	92.5	3.86	113.0	4.27	133.5	4.68	159.0	5.09	186.8	5.50	210.0		
2.23	42.4	2.64	57.7	3.05	73.1	3.46	93.0	3.87	113.5	4.28	134.0	4.69	159.5	5.10	187.5	5.51	210.8		
2.24	42.7	2.65	58.1	3.06	73.5	3.47	93.5	3.88	114.0	4.29	134.5	4.70	160.0	5.11	188.3	5.52	211.5		
2.25	43.1	2.66	58.5	3.07	73.9	3.48	94.0	3.89	114.5	4.30	135.0	4.71	160.5	5.12	189.0	5.53	212.3		
2.26	43.5	2.67	58.9	3.08	74.2	3.49	94.5	3.90	115.0	4.31	135.8	4.72	161.0	5.13	189.8	5.54	213.0		
2.27	43.9	2.68	59.2	3.09	74.6	3.50	95.0	3.91	115.5	4.32	136.5	4.73	161.5	5.14	190.5	5.55	213.8		
2.28	44.2	2.69	59.6	3.10	75.0	3.51	95.5	3.92	116.0	4.33	137.3	4.74	162.0	5.15	191.3	5.56	214.5		
2.29	44.6	2.70	60.0	3.11	75.5	3.52	96.0	3.93	116.5	4.34	138.0	4.75	162.5	5.16	192.0	5.57	215.3		
2.30	45.0	2.71	60.4	3.12	76.0	3.53	96.5	3.94	117.0	4.35	138.8	4.76	163.0	5.17	192.8	5.58	216.0		