

4-Hour Fire Rating

6" C.M.U.

Fire Rating: 4 Hour

No. 6-4-910350GFD

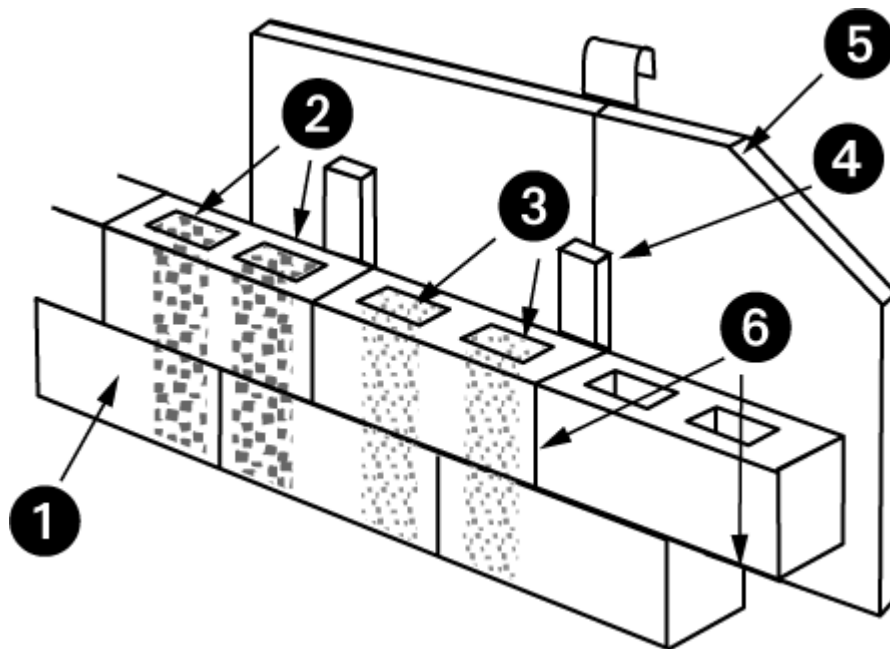

Assembly Information

1. Preferred product 910350 c.m.u. 6" x 8" x 16" nominal

2. Masonry grout -all cells filled

OR

3. Approved loose fill material - all cells filled*

4. Wood or steel furring members - 16" o.c. maximum

5. Gypsum wallboard - Type "X", 5/8" thick, long dimension parallel to furring members - all joints finished.

6. ASTM C-270 Masonry Mortar, Type M or S. Face shell or full mortar bedding as required.

7. Masonry grout, reinforcing steel, joint reinforcement, anchors, ties and accessories (Not depicted above - optional). Use where specified.

*Approved loose fill materials include: sand, pea gravel, crushed stone or slag that meet ASTM C33 requirements; pumice, scoria, expanded shale, expanded clay, expanded slate, expanded slag, expanded fly ash, or cinders in compliance with ASTM C331; perlite or vermiculite that complies with ASTM C332 or ASTM C549 and C516, respectively.

Preferred Materials Inc. accepts no responsibility for proper application of the rated wall assembly above, or responsibility for the construction of such assemblies.

Fire Rating: 4 Hour No. 6-4-910350GFD

Concrete Masonry Unit

Section 721.3.2 of the Florida Building Code

Unit Description	Size WxHxL Nominal	Equivalent Thickness Inches	Fire Rating Minutes
910350	6x8x16	3.2	77.2*

** Linear interpolation from Table 721.3.2 of the Florida Building Code for Exposed Finish Block Mix – 55% limestone & 45% siliceous aggregates.*

Section 721.3.1.3 and 721.3.1.4 of the Florida Building Code

Solid Grouted construction and/or cells filled with loose-fill materials

Included	Equivalent Thickness Inches	Fire Rating Minutes
No	N/A	N/A
Yes	5.62	209

** Linear interpolation from Table 721.3.2 of the Florida Building Code for Exposed Finish Block Mix – 55% limestone & 45% siliceous aggregates.*

Fire Rating: 4 Hour

No. 6-4-910350GFD

Nonfire-exposed side

Side 1

Section 721.3.2.1 of the Florida Building Code

Finish	
5/8 inch thick Gypsum Wallboard Type X	.625
Multiplying factor Table 721.2.1.4(1)	1
Adjusted Thickness	.625
Concrete Masonry Unit	
Unit Description	910350
Size WxHxL Nominal	6x8x16
Equivalent Thickness	5.62
Fire Rating Minutes	209
Total Thickness, CMU + Finish	6.24
Fire Resistance Rating of CMU & Finish, Table 721.3.2	240*

** Linear interpolation from Table 721.3.2 of the Florida Building Code for Exposed Finish Block Mix – 55% limestone & 45% siliceous aggregates.*

Side 2

Section 721.3.2.1 of the Florida Building Code

Finish	
None	0
Multiplying factor Table 721.2.1.4(1)	N/A
Adjusted Thickness (inches)	0
Concrete Masonry Unit	
Unit Description	910350
Size WxHxL Nominal	6x8x16
Equivalent Thickness (inches)	5.62
Fire Rating Minutes	209
Total Thickness, CMU + Finish (inches)	5.62
Fire Resistance Rating of CMU & Finish, Table 721.3.2	209*

** Linear interpolation from Table 721.3.2 of the Florida Building Code for Exposed Finish Block Mix – 55% limestone & 45% siliceous aggregates.*

Fire Rating: 4 Hour No. 6-4-910350GFD

Fire-exposed side

Side 1

Section 721.3.2.2 of the Florida Building Code

Finish	
None	
Time assigned to finish materials Table 721.2.1.4(2)	0
Fire Resistance of CMU and Nonfire-exposed side Finish Table 721.3.2	240
Assembly Fire-Resistance Rating	240
Max. allowable assembly Fire Resistance Block + finishes	418
Total Assembly Fire-Resistance Rating	240

Side 2

Section 721.3.2.2 of the Florida Building Code

Finish	
5/8 inch thick Gypsum Wallboard Type X	
Time assigned to finish materials Table 721.2.1.4(2)	40
Fire Resistance of CMU and Nonfire-exposed side Finish Table 721.3.2	209
Assembly Fire-Resistance Rating	249
Max. allowable assembly Fire Resistance Block + finishes	418
Total Assembly Fire-Resistance Rating	240

Assembly Fire-Resistance Rating	240 Minutes
--	--------------------

**Fire Resistance Rating, minutes per inches of equivalent thickness
 Linear Interpolation from table 721.3.2 of the 2007 Florida Building Code
 Exposed Finish Block Mix – 55% Limestone & 45% Siliceous Aggregates**

1.95	30.0	2.36	45.4	2.77	60.8	3.18	76.3	3.59	95.0	4.00	115.5	4.41	136.2	4.82	160.8	5.23	186.8	5.64	210.0
1.96	30.4	2.37	45.8	2.78	61.1	3.19	76.8	3.60	95.5	4.01	116.0	4.42	136.8	4.83	161.4	5.24	187.5	5.65	210.8
1.97	30.8	2.38	46.1	2.79	61.5	3.20	77.2	3.61	96.0	4.02	116.5	4.43	137.4	4.84	162.0	5.25	188.3	5.66	211.5
1.98	31.1	2.39	46.5	2.80	61.9	3.21	77.6	3.62	96.5	4.03	117.0	4.44	138.0	4.85	162.6	5.26	189.0	5.67	212.3
1.99	31.5	2.40	46.9	2.81	62.3	3.22	78.1	3.63	97.0	4.04	117.5	4.45	138.6	4.86	163.2	5.27	189.8	5.68	213.0
2.00	31.9	2.41	47.3	2.82	62.6	3.23	78.5	3.64	97.5	4.05	118.0	4.46	139.2	4.87	163.8	5.28	190.5	5.69	213.8
2.01	32.3	2.42	47.6	2.83	63.0	3.24	79.0	3.65	98.0	4.06	118.5	4.47	139.8	4.88	164.4	5.29	191.3	5.70	214.5
2.02	32.6	2.43	48.0	2.84	63.4	3.25	79.4	3.66	98.5	4.07	119.0	4.48	140.4	4.89	165.0	5.30	192.0	5.71	215.3
2.03	33.0	2.44	48.4	2.85	63.7	3.26	79.9	3.67	99.0	4.08	119.5	4.49	141.0	4.90	165.6	5.31	192.8	5.72	216.0
2.04	33.4	2.45	48.7	2.86	64.1	3.27	80.3	3.68	99.5	4.09	120.0	4.50	141.6	4.91	166.2	5.32	193.5	5.73	216.8
2.05	33.8	2.46	49.1	2.87	64.5	3.28	80.7	3.69	100.0	4.10	120.5	4.51	142.2	4.92	166.8	5.33	194.3	5.74	217.5
2.06	34.1	2.47	49.5	2.88	64.9	3.29	81.2	3.70	100.5	4.11	121.0	4.52	142.8	4.93	167.4	5.34	195.0	5.75	218.3
2.07	34.5	2.48	49.9	2.89	65.2	3.30	81.6	3.71	101.0	4.12	121.5	4.53	143.4	4.94	168.0	5.35	195.5	5.76	219.0
2.08	34.9	2.49	50.2	2.90	65.6	3.31	82.1	3.72	101.5	4.13	122.0	4.54	144.0	4.95	168.6	5.36	196.0	5.77	219.8
2.09	35.2	2.50	50.6	2.91	66.0	3.32	82.5	3.73	102.0	4.14	122.5	4.55	144.6	4.96	169.2	5.37	196.5	5.78	220.5
2.10	35.6	2.51	51.0	2.92	66.4	3.33	82.9	3.74	102.5	4.15	123.0	4.56	145.2	4.97	169.8	5.38	197.0	5.79	221.3
2.11	36.0	2.52	51.4	2.93	66.7	3.34	83.4	3.75	103.0	4.16	123.5	4.57	145.8	4.98	170.4	5.39	197.5	5.80	222.0
2.12	36.4	2.53	51.7	2.94	67.1	3.35	83.8	3.76	103.5	4.17	124.0	4.58	146.4	4.99	171.0	5.40	198.0	5.81	222.8
2.13	36.7	2.54	52.1	2.95	67.5	3.36	84.3	3.77	104.0	4.18	124.5	4.59	147.0	5.00	171.6	5.41	198.5	5.82	223.5
2.14	37.1	2.55	52.5	2.96	67.9	3.37	84.7	3.78	104.5	4.19	125.0	4.60	147.6	5.01	172.2	5.42	199.0	5.83	224.3
2.15	37.5	2.56	52.9	2.97	68.2	3.38	85.1	3.79	105.0	4.20	125.5	4.61	148.2	5.02	172.8	5.43	199.5	5.84	225.0
2.16	37.9	2.57	53.2	2.98	68.6	3.39	85.6	3.80	105.5	4.21	126.0	4.62	148.8	5.03	173.4	5.44	200.0	5.85	225.8
2.17	38.2	2.58	53.6	2.99	69.0	3.40	86.0	3.81	106.0	4.22	126.5	4.63	149.4	5.04	174.0	5.45	200.5	5.86	226.5
2.18	38.6	2.59	54.0	3.00	69.4	3.41	86.5	3.82	106.5	4.23	127.0	4.64	150.0	5.05	174.6	5.46	201.0	5.87	227.3
2.19	39.0	2.60	54.4	3.01	69.7	3.42	86.9	3.83	107.0	4.24	127.5	4.65	150.6	5.06	175.2	5.47	201.5	5.88	228.0
2.20	39.4	2.61	54.7	3.02	70.1	3.43	87.3	3.84	107.5	4.25	128.0	4.66	151.2	5.07	175.8	5.48	202.0	5.89	228.8
2.21	39.7	2.62	55.1	3.03	70.5	3.44	87.8	3.85	108.0	4.26	128.5	4.67	151.8	5.08	176.4	5.49	202.5	5.90	229.5
2.22	40.1	2.63	55.5	3.04	70.9	3.45	88.2	3.86	108.5	4.27	129.0	4.68	152.4	5.09	177.0	5.50	203.0	5.91	230.3
2.23	40.5	2.64	55.9	3.05	71.2	3.46	88.7	3.87	109.0	4.28	129.5	4.69	153.0	5.10	177.6	5.51	203.5	5.92	231.0
2.24	40.9	2.65	56.2	3.06	71.6	3.47	89.1	3.88	109.5	4.29	130.0	4.70	153.6	5.11	178.2	5.52	204.0	5.93	231.8
2.25	41.2	2.66	56.6	3.07	72.0	3.48	89.6	3.89	110.0	4.30	130.5	4.71	154.2	5.12	178.8	5.53	204.5	5.94	232.5
2.26	41.6	2.67	57.0	3.08	72.4	3.49	90.0	3.90	110.5	4.31	131.0	4.72	154.8	5.13	179.4	5.54	205.0	5.95	233.3
2.27	42.0	2.68	57.4	3.09	72.7	3.50	90.5	3.91	111.0	4.32	131.5	4.73	155.4	5.14	180.0	5.55	205.5	5.96	234.0
2.28	42.4	2.69	57.7	3.10	73.1	3.51	91.0	3.92	111.5	4.33	132.0	4.74	156.0	5.15	180.8	5.56	206.0	5.97	234.8
2.29	42.7	2.70	58.1	3.11	73.5	3.52	91.5	3.93	112.0	4.34	132.5	4.75	156.6	5.16	181.5	5.57	206.5	5.98	235.5
2.30	43.1	2.71	58.5	3.12	73.9	3.53	92.0	3.94	112.5	4.35	133.0	4.76	157.2	5.17	182.3	5.58	207.0	5.99	236.3
2.31	43.5	2.72	58.9	3.13	74.2	3.54	92.5	3.95	113.0	4.36	133.5	4.77	157.8	5.18	183.0	5.59	207.5	6.00	237.0
2.32	43.9	2.73	59.2	3.14	74.6	3.55	93.0	3.96	113.5	4.37	134.0	4.78	158.4	5.19	183.8	5.60	208.0	6.01	237.8
2.33	44.2	2.74	59.6	3.15	75.0	3.56	93.5	3.97	114.0	4.38	134.5	4.79	159.0	5.20	184.5	5.61	208.5	6.02	238.5
2.34	44.6	2.75	60.0	3.16	75.4	3.57	94.0	3.98	114.5	4.39	135.0	4.80	159.6	5.21	185.3	5.62	209.0	6.03	239.3
2.35	45.0	2.76	60.4	3.17	75.9	3.58	94.5	3.99	115.0	4.40	135.6	4.81	160.2	5.22	186.0	5.63	209.5	6.04	240.0

Fire Resistance Rating, minutes per inches of equivalent thickness
Direct Interpolation from table 721.3.2 of the 2007 Florida Building Code
Stucco/Sand Finish Block Mix – 100% Limestone

1.90	30.0	2.31	45.4	2.72	60.8	3.13	76.5	3.54	97.0	3.95	117.5	4.36	139.5	4.77	163.5	5.18	193.5	5.59	216.8
1.91	30.4	2.32	45.8	2.73	61.1	3.14	77.0	3.55	97.5	3.96	118.0	4.37	140.3	4.78	164.0	5.19	194.3	5.60	217.5
1.92	30.8	2.33	46.1	2.74	61.5	3.15	77.5	3.56	98.0	3.97	118.5	4.38	141.0	4.79	164.5	5.20	195.0	5.61	218.3
1.93	31.1	2.34	46.5	2.75	61.9	3.16	78.0	3.57	98.5	3.98	119.0	4.39	141.8	4.80	165.0	5.21	195.5	5.62	219.0
1.94	31.5	2.35	46.9	2.76	62.3	3.17	78.5	3.58	99.0	3.99	119.5	4.40	142.5	4.81	165.8	5.22	196.0	5.63	219.8
1.95	31.9	2.36	47.3	2.77	62.6	3.18	79.0	3.59	99.5	4.00	120.0	4.41	143.3	4.82	166.5	5.23	196.5	5.64	220.5
1.96	32.3	2.37	47.6	2.78	63.0	3.19	79.5	3.60	100.0	4.01	120.5	4.42	144.0	4.83	167.3	5.24	197.0	5.65	221.3
1.97	32.6	2.38	48.0	2.79	63.4	3.20	80.0	3.61	100.5	4.02	121.0	4.43	144.8	4.84	168.0	5.25	197.5	5.66	222.0
1.98	33.0	2.39	48.4	2.80	63.7	3.21	80.5	3.62	101.0	4.03	121.5	4.44	145.5	4.85	168.8	5.26	198.0	5.67	222.8
1.99	33.4	2.40	48.8	2.81	64.1	3.22	81.0	3.63	101.5	4.04	122.0	4.45	146.3	4.86	169.5	5.27	198.5	5.68	223.5
2.00	33.8	2.41	49.1	2.82	64.5	3.23	81.5	3.64	102.0	4.05	122.5	4.46	147.0	4.87	170.3	5.28	199.0	5.69	224.3
2.01	34.1	2.42	49.5	2.83	64.9	3.24	82.0	3.65	102.5	4.06	123.0	4.47	147.8	4.88	171.0	5.29	199.5	5.70	225.0
2.02	34.5	2.43	49.9	2.84	65.2	3.25	82.5	3.66	103.0	4.07	123.5	4.48	148.5	4.89	171.8	5.30	200.0	5.71	225.8
2.03	34.9	2.44	50.3	2.85	65.6	3.26	83.0	3.67	103.5	4.08	124.0	4.49	149.3	4.90	172.5	5.31	200.5	5.72	226.5
2.04	35.3	2.45	50.6	2.86	66.0	3.27	83.5	3.68	104.0	4.09	124.5	4.50	150.0	4.91	173.3	5.32	201.0	5.73	227.3
2.05	35.6	2.46	51.0	2.87	66.4	3.28	84.0	3.69	104.5	4.10	125.0	4.51	150.5	4.92	174.0	5.33	201.5	5.74	228.0
2.06	36.0	2.47	51.4	2.88	66.7	3.29	84.5	3.70	105.0	4.11	125.5	4.52	151.0	4.93	174.8	5.34	202.0	5.75	228.8
2.07	36.4	2.48	51.7	2.89	67.1	3.30	85.0	3.71	105.5	4.12	126.0	4.53	151.5	4.94	175.5	5.35	202.5	5.76	229.5
2.08	36.7	2.49	52.1	2.90	67.5	3.31	85.5	3.72	106.0	4.13	126.5	4.54	152.0	4.95	176.3	5.36	203.0	5.77	230.3
2.09	37.1	2.50	52.5	2.91	67.9	3.32	86.0	3.73	106.5	4.14	127.0	4.55	152.5	4.96	177.0	5.37	203.5	5.78	231.0
2.10	37.5	2.51	52.9	2.92	68.2	3.33	86.5	3.74	107.0	4.15	127.5	4.56	153.0	4.97	177.8	5.38	204.0	5.79	231.8
2.11	37.9	2.52	53.2	2.93	68.6	3.34	87.0	3.75	107.5	4.16	128.0	4.57	153.5	4.98	178.5	5.39	204.5	5.80	232.5
2.12	38.2	2.53	53.6	2.94	69.0	3.35	87.5	3.76	108.0	4.17	128.5	4.58	154.0	4.99	179.3	5.40	205.0	5.81	233.3
2.13	38.6	2.54	54.0	2.95	69.4	3.36	88.0	3.77	108.5	4.18	129.0	4.59	154.5	5.00	180.0	5.41	205.5	5.82	234.0
2.14	39.0	2.55	54.4	2.96	69.7	3.37	88.5	3.78	109.0	4.19	129.5	4.60	155.0	5.01	180.8	5.42	206.0	5.83	234.8
2.15	39.4	2.56	54.7	2.97	70.1	3.38	89.0	3.79	109.5	4.20	130.0	4.61	155.5	5.02	181.5	5.43	206.5	5.84	235.5
2.16	39.7	2.57	55.1	2.98	70.5	3.39	89.5	3.80	110.0	4.21	130.5	4.62	156.0	5.03	182.3	5.44	207.0	5.85	236.3
2.17	40.1	2.58	55.5	2.99	70.9	3.40	90.0	3.81	110.5	4.22	131.0	4.63	156.5	5.04	183.0	5.45	207.5	5.86	237.0
2.18	40.5	2.59	55.9	3.00	71.2	3.41	90.5	3.82	111.0	4.23	131.5	4.64	157.0	5.05	183.8	5.46	208.0	5.87	237.8
2.19	40.9	2.60	56.2	3.01	71.6	3.42	91.0	3.83	111.5	4.24	132.0	4.65	157.5	5.06	184.5	5.47	208.5	5.88	238.5
2.20	41.2	2.61	56.6	3.02	72.0	3.43	91.5	3.84	112.0	4.25	132.5	4.66	158.0	5.07	185.3	5.48	209.0	5.89	239.3
2.21	41.6	2.62	57.0	3.03	72.4	3.44	92.0	3.85	112.5	4.26	133.0	4.67	158.5	5.08	186.0	5.49	209.5	5.90	240.0
2.22	42.0	2.63	57.4	3.04	72.7	3.45	92.5	3.86	113.0	4.27	133.5	4.68	159.0	5.09	186.8	5.50	210.0		
2.23	42.4	2.64	57.7	3.05	73.1	3.46	93.0	3.87	113.5	4.28	134.0	4.69	159.5	5.10	187.5	5.51	210.8		
2.24	42.7	2.65	58.1	3.06	73.5	3.47	93.5	3.88	114.0	4.29	134.5	4.70	160.0	5.11	188.3	5.52	211.5		
2.25	43.1	2.66	58.5	3.07	73.9	3.48	94.0	3.89	114.5	4.30	135.0	4.71	160.5	5.12	189.0	5.53	212.3		
2.26	43.5	2.67	58.9	3.08	74.2	3.49	94.5	3.90	115.0	4.31	135.8	4.72	161.0	5.13	189.8	5.54	213.0		
2.27	43.9	2.68	59.2	3.09	74.6	3.50	95.0	3.91	115.5	4.32	136.5	4.73	161.5	5.14	190.5	5.55	213.8		
2.28	44.2	2.69	59.6	3.10	75.0	3.51	95.5	3.92	116.0	4.33	137.3	4.74	162.0	5.15	191.3	5.56	214.5		
2.29	44.6	2.70	60.0	3.11	75.5	3.52	96.0	3.93	116.5	4.34	138.0	4.75	162.5	5.16	192.0	5.57	215.3		
2.30	45.0	2.71	60.4	3.12	76.0	3.53	96.5	3.94	117.0	4.35	138.8	4.76	163.0	5.17	192.8	5.58	216.0		